

kdl*n*

ASSEMBLY INSTRUCTIONS
INSTRUCCIONES DE MONTAJE

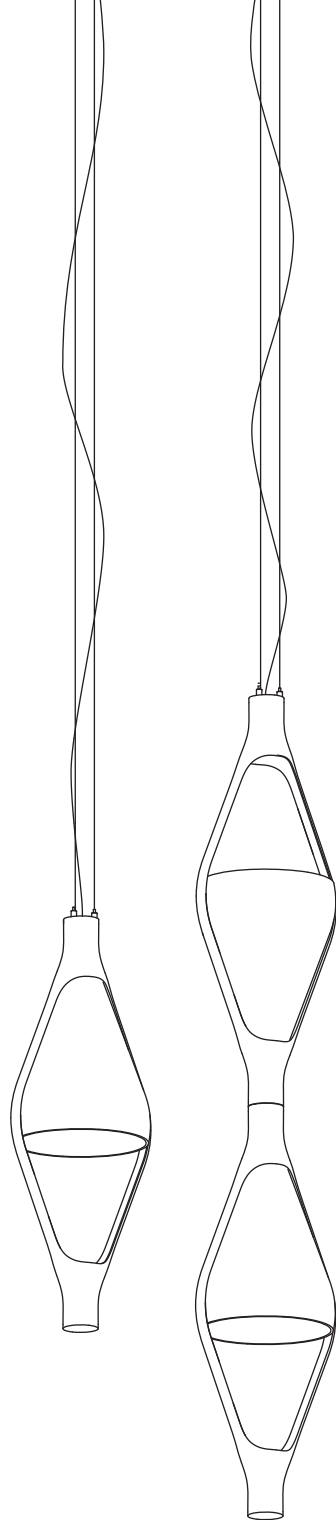

VICEVERSA US

NOÉ DUCHAUFOUR LAWRENCE

WARNING

The safety is guaranteed by the appropriate use of the following instructions, so you must keep them.

Always disconnect the main voltage before working on the appliance.

Never use abrasive products or aggressive detergents for cleaning the lamp.

If the external cable of this appliance is damaged, it must be replaced by the manufacturer, its after sales service or other equivalent qualified person only in order to avoid any danger.

Kdln will not provide a replacement until the nature of defect has been determined.

ATTENTION

La sûreté de l'appareil n'est garantie qu'en suivant scrupuleusement les instructions ci-après.

Il est donc nécessaire de les conserver.

Isoler l'appareil du secteur avant toute manipulation.

Pour nettoyer la lampe, ne jamais utiliser de produits abrasifs ou de nettoyeurs agressifs.

Si le câble externe de cet appareil est endommagé, il doit être remplacé uniquement par les soins du constructeur, par son service après-vente ou bien par le personnel équivalent, et ce afin d'éviter tout danger.

Kdln ne remplacera aucun appareil sans en avoir pu vérifier le défaut.

Viceversa

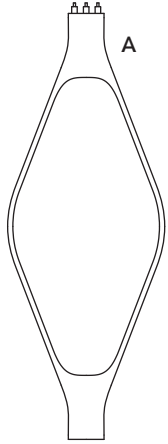

BOXN.1 - A

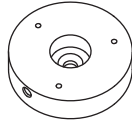

2x

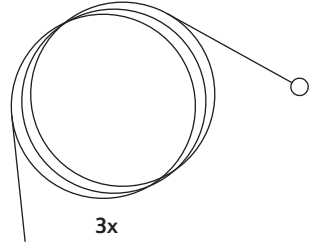
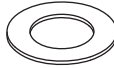

3x

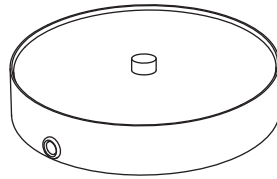

cod. 370280_US_

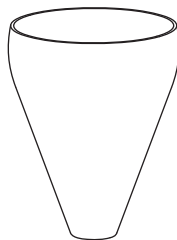

BOXN.2

cod. 370VE_

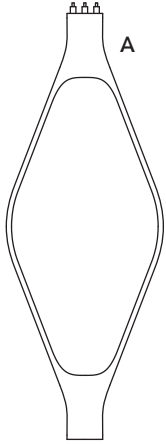

BOX N.1 - A

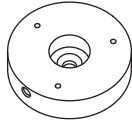

2x

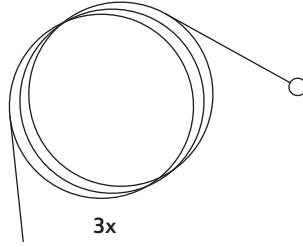
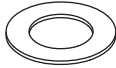

3x

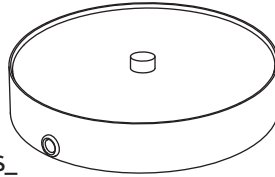

cod. 370280_US_

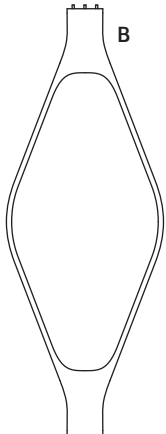

BOX N.2 - B

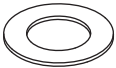

3x

cod. 370281_US

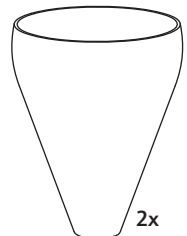

2x

BOX N.3 - 4

cod. 370VE_

Viceversa

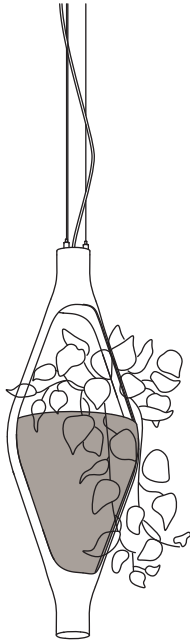

vase load
max 6 kg / 13 lbs

charge du vase
max 6 kg / 13 lbs

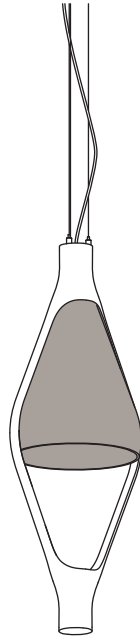

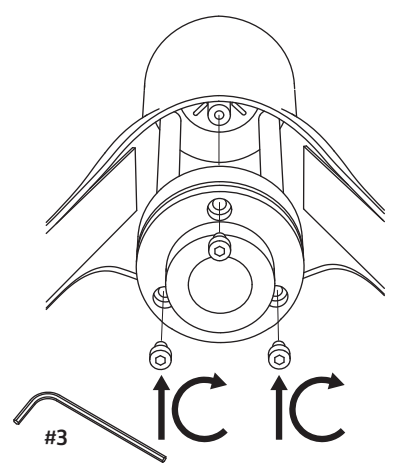
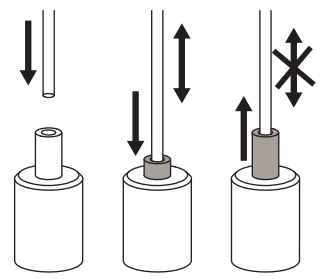
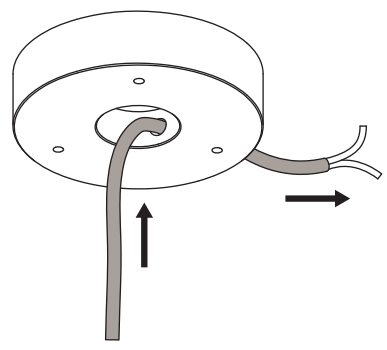
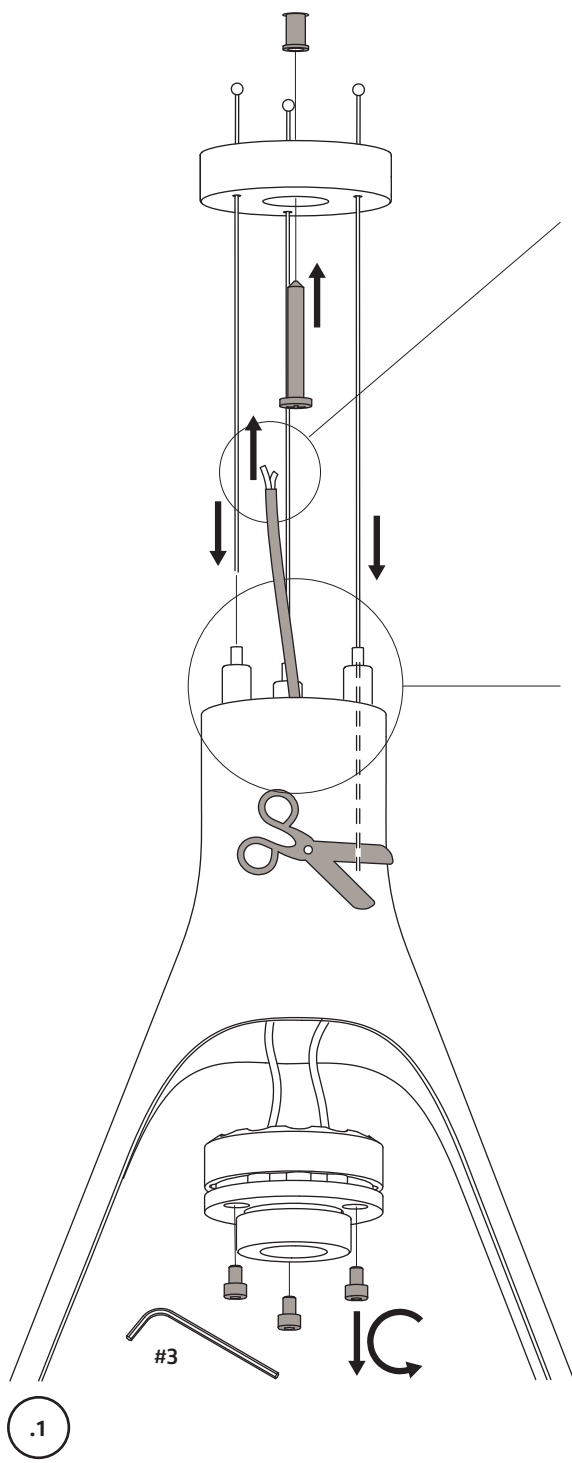

This luminaire must be mounted independently of an outlet box.
Ce luminaire doit être monté indépendamment d'un boîtier de prise.

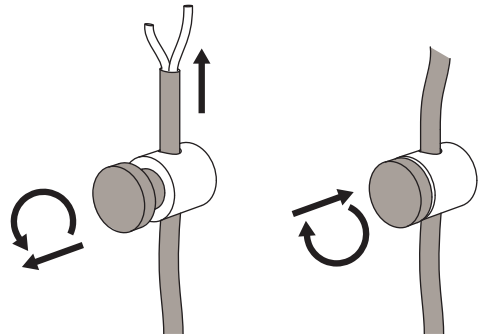
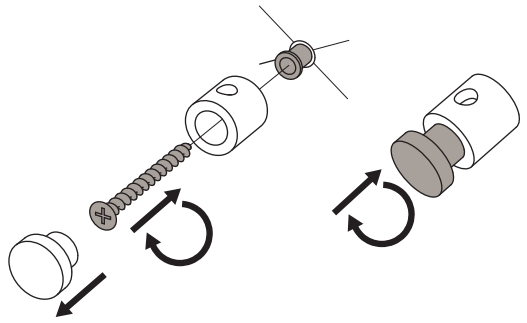
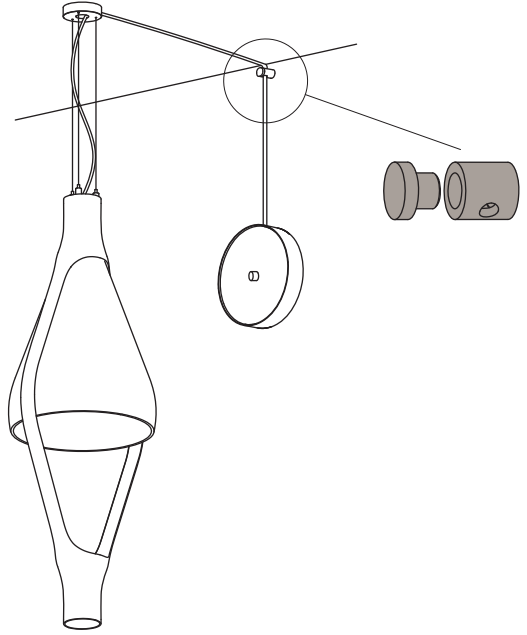
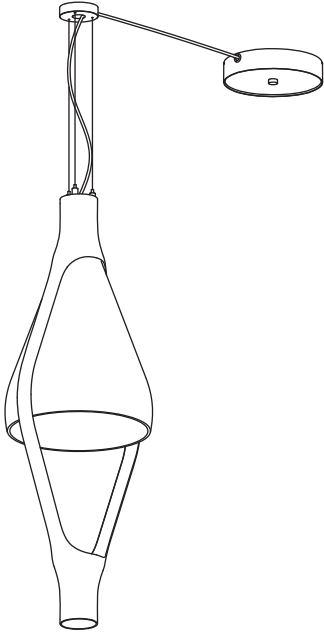

To inspect the electrical connections, remove the electrical structure and the back enclosure by unscrewing the highlighted screw.

Pour inspecter les connexions électriques, retirez la structure électrique et le boîtier arrière en dévissant la vis mise en évidence.

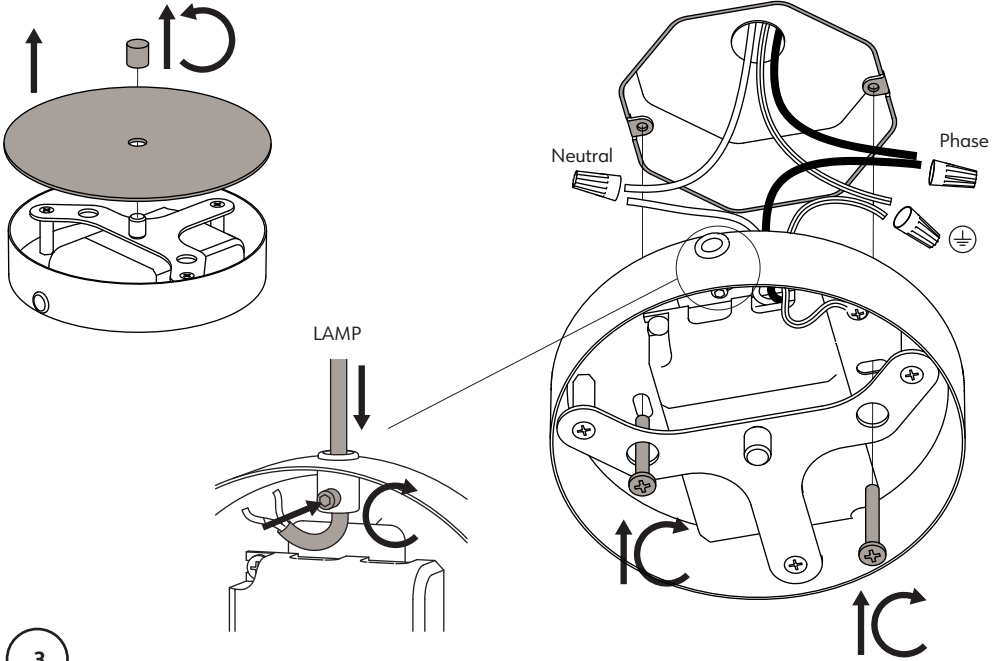

3

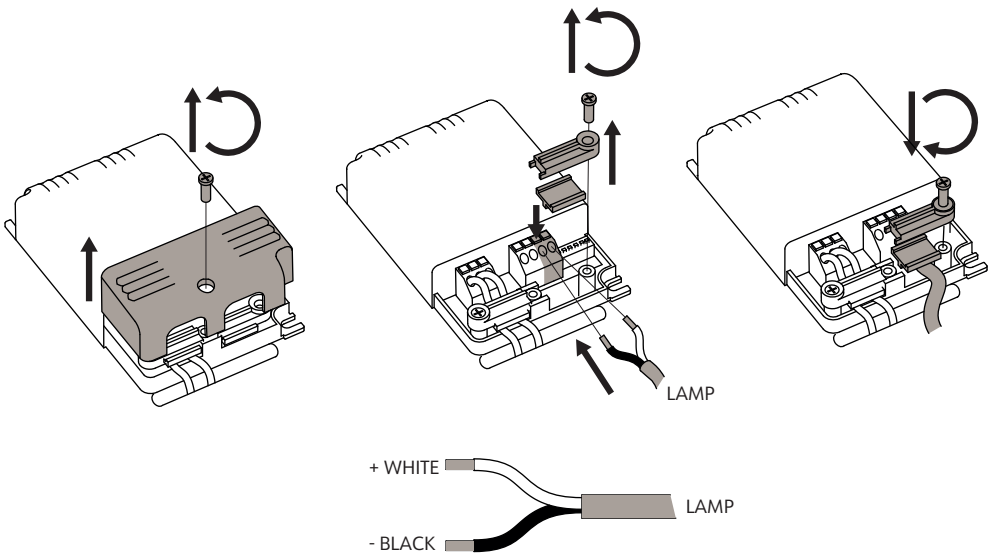

4

ON-OFF wiring diagram

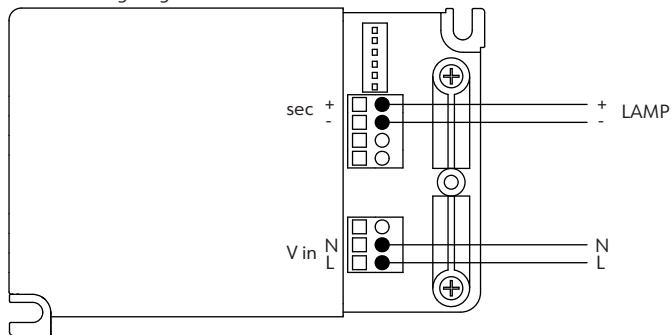

PUSH wiring diagram

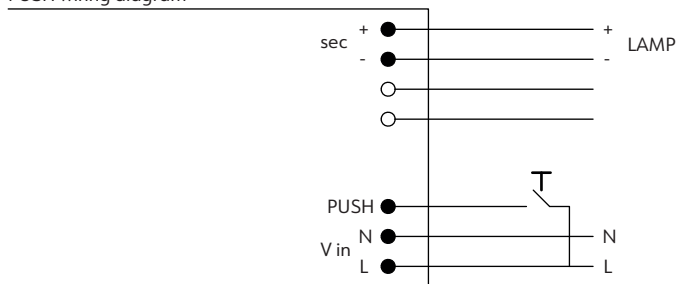

1-10V wiring diagram

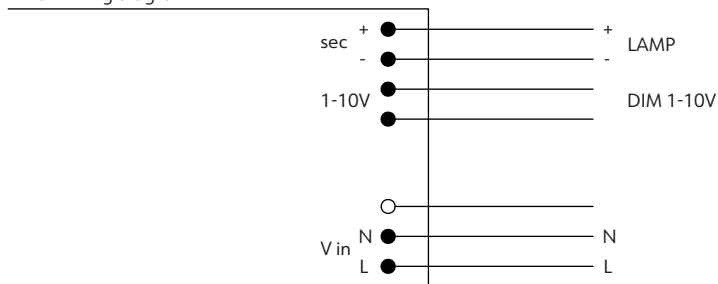

DALI wiring diagram

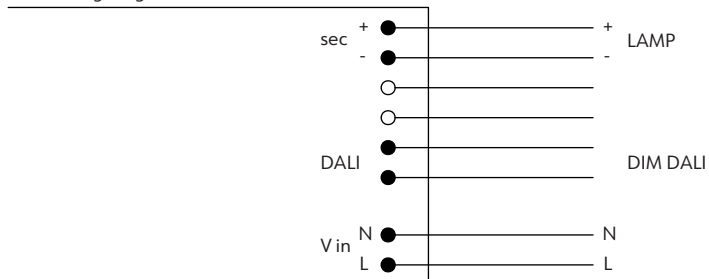

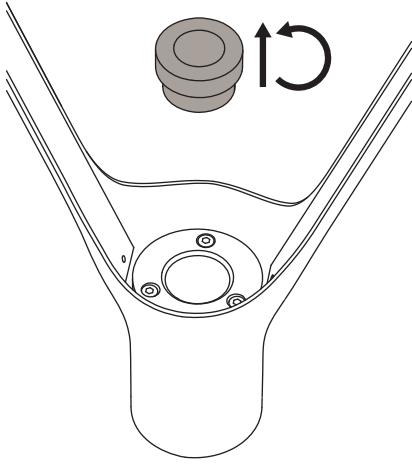

.6

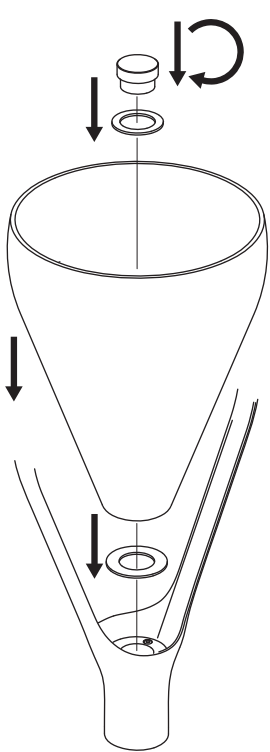

.7

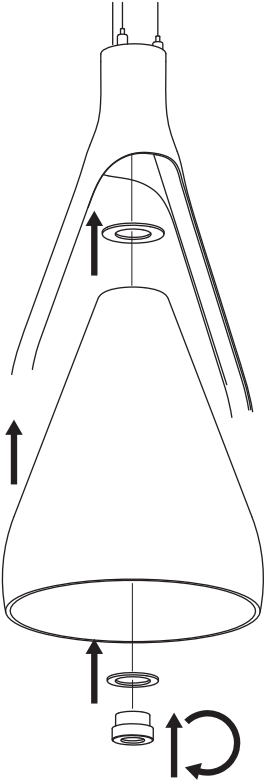



120°



240°

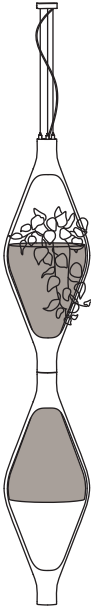
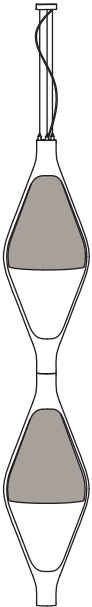

vase load
max 6 kg / 13 lbs

charge du vase
max 6 kg / 13 lbs

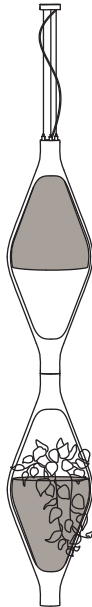

vase load
max 6 kg / 13 lbs

charge du vase
max 6 kg / 13 lbs



vase load
max 6 kg / 13 lbs

charge du vase
max 6 kg / 13 lbs

vase load
max 6 kg / 13 lbs

charge du vase
max 6 kg / 13 lbs

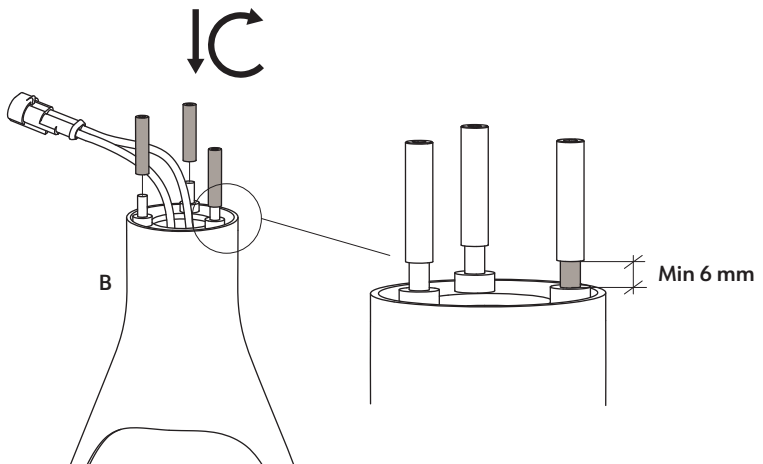
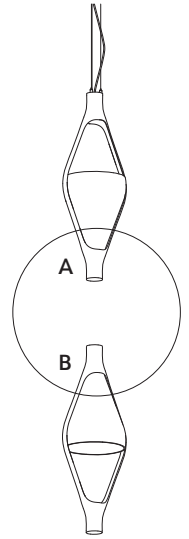
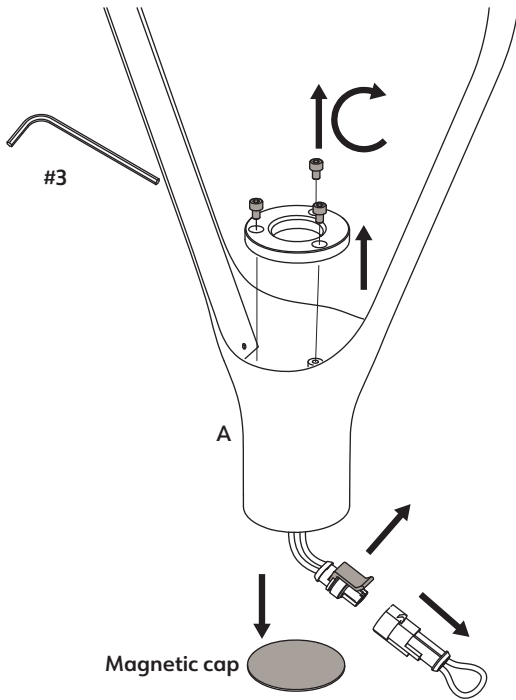

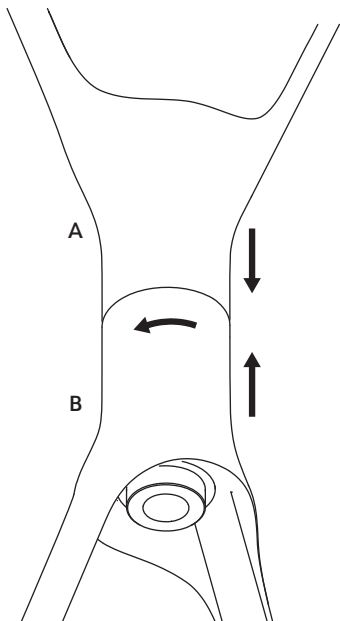
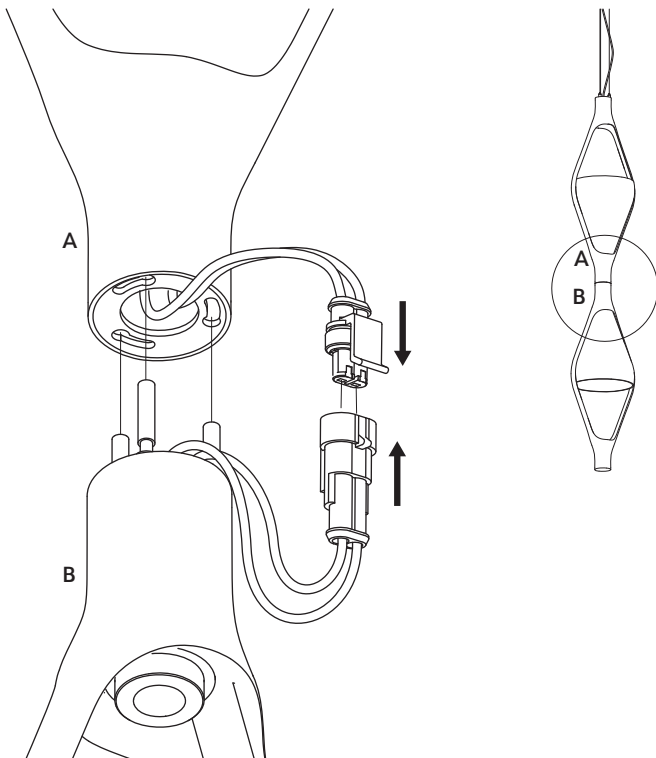

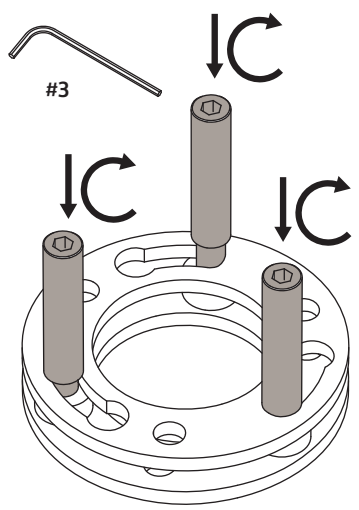
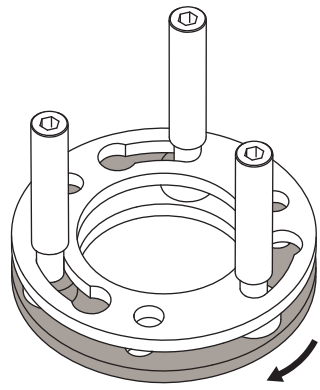
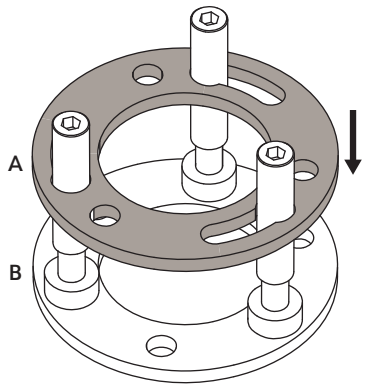
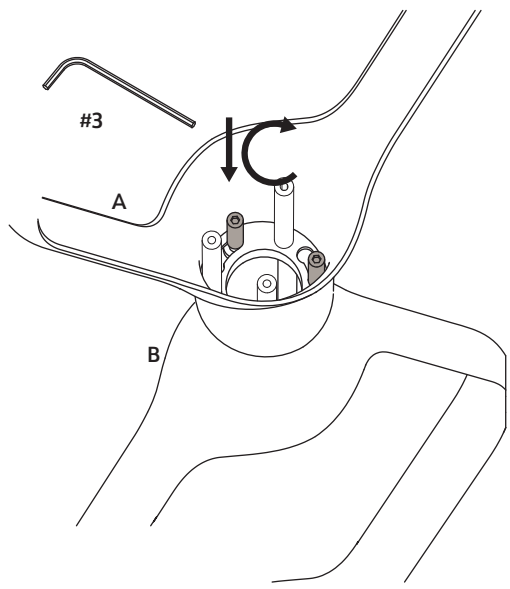

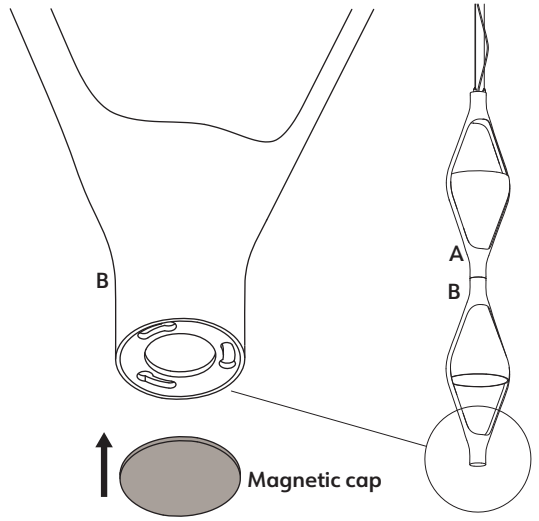
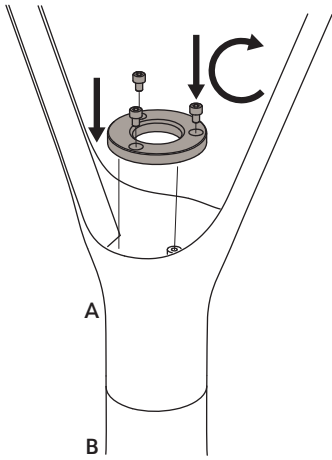

.11

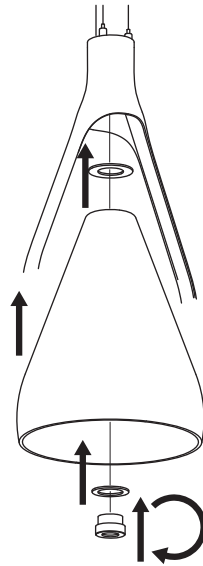
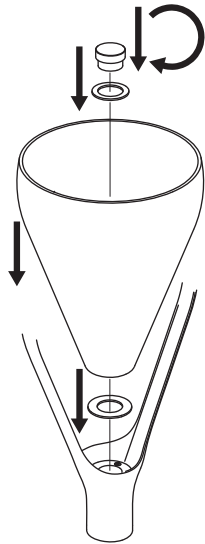

.12

BULBS, AMPOULES

Viceversa
 Board LED 1 x 9.6W
 Viceversa 2
 Board LED 2 x 9.6W

FEEDING, ALIMENTATION

110-120 V - 50/60 Hz

